

Current part is item (23) on diagram. Available at www.oshkosequipment.com

(1) SMR Code	(2) Federal Stock Number	DESCRIPTION	UNIT of meas	Qty inc. in Unit	30-day DS maint allowance			30-day GS maint allowance			1-yr alw per 100 equip cnt- gcy	Depot maint alw per 100 equip	Illustration	
					(a) 1-20	(b) 21-50	(c) 51-100	(a) 1-20	(b) 21-50	(c) 51-100			(a) Figure No.	(b) Item No.
		Reference Number & Mfr. Code												
		Usable On Code												
PAHZZ	6680-179-5125	SLEEVE: TACHOMETER DRIVE 10889925 (19207)	EA	1				*	*	*	*	*	6	8
PAHZZ	5315-011-2139	KEY,WOODRUFF: GEAR MTG 112139 (24617)	EA	1				*	*	*	*	*	6	9
PAHZZ	2815-861-3831	THRUST PLATE, CAMSHAFT: 10889837 (19207)	EA	1				*	*	*	*	*	6	10
PAFZZ	5310-959-4675	WASHER, LOCK: THRUST PLATE, GEAR COVER AND ACCESS COVER MTG MS35340-46 (96906)	EA	15	*	*	*	*	*	*	*	*	6	11
PAHZZ	5305-269-3211	SCREW, CAP, HEXAGON HEAD: THRUST PLATE MTG MS90725-60 (96906)	EA	2				*	*	*	*	*	6	12
PBFZZ	2815-177-9209	GEAR, CAM SHAFT TIMING: 10889822 (19207)	EA	1	*	*	*	*	*	*	*	*	6	13
PAFZZ	5310-930-7979	NUT, SELF-LOCKING, HEXAGON: GEAR MTG 11602502 (19207)	EA	1	*	*	*	*	*	*	*	*	6	14
PAFZZ	5310-732-0558	NUT, PLAIN, HEXAGON: GEAR COVER AND ACESS COVER MTG MS51967-8 (96906)	EA	6	*	*	*	*	*	*	*	*	6	15
PAFZZ	5305-269-3213	SCREW, CAP, HEXAGON HEAD: GEAR COVER TO FRONT PLATE MTG MS90725-62 (96906)	EA	1	*	*	*	*	*	*	*	*	6	16
PAFZZ	5305-050-1077	SCREW, CAP, HEXAGON HEAD: GEAR COVER TO FRONT PLATE MTG MS90725-118 (96906)	EA	1	*	*	*	*	*	*	*	*	6	17
PAFZZ	2910-862-9065	GASKET: ACCESS COVER MTG 10889724 (19207)	EA	1	*	*	*	*	*	*	*	*	6	18
PAFZZ	5340-450-6720	COVER, ACCESS: INJECTION PUMP DRIVE 10951005 (19207)	EA	1	*	*	*	*	*	*	*	*	6	19
PAFZZ	2815-808-7366	DEFLECTER, DIRT AND LIQUID: GEAR COVER 11610423 (19207)	EA	1	*	*	*	*	*	*	*	*	6	20
PAFZZ	5305-269-4511	SCREW, CAP, HEXAGON HEAD: GEAR COVER TO FRONT PLATE MTG MS90725-63 (96906)	EA	6	*	*	*	*	*	*	*	*	6	21
PRFZZ	2815-411-5791	COVER, TIMING GEAR: 10899082 (19207)	EA	1	*	*	*	*	*	*	*	*	6	22
XAFZZ		COVER, GEAR: 10899082-1 (19207)	EA	1	*	*	*	*	*	*	*	*	6	23
XAFZZ		PIN: COVER LOCATING 103813 (21450)	EA	2	*	*	*	*	*	*	*	*	6	24
PAFZZ	5307-420-9787	STUD, PLAIN: ACCESS COVER MTG 10899066 (19207)	EA	1	*	*	*	*	*	*	*	*	6	25
PAFZZ	5307-851-8981	STUD, PLAIN: ACCESS COVER MTG, 0.003 IN. OVERSIZE 10899092 (19207)	EA	1	*	*	*	*	*	*	*	*	6	25
PAFZZ	5307-087-7531	STUD, PLAIN: ACCESS COVER MTG, 0.003 IN. OVERSIZE 10912511-3 (19207)	EA	1	*	*	*	*	*	*	*	*	6	26
PAFZZ	2815-860-0560	GASKET: GEAR COVER MTG 10889736 (19207)	EA	1	*	*	*	*	*	*	*	*	6	27
PAFZZ	5315-406-3419	KEY,WOODRUFF: GEAR MTG 7748817 (19207)	EA	1	*	*	*	*	*	*	*	*	6	28
PAFZZ	5310-768-0318	NUT, PLAIN, HEXAGON: GEAR COVER TO FRONT PLATE MTG MS51967-14 (96906)	EA	1	*	*	*	*	*	*	*	*	6	29
PAFZZ	5310-834-7606	WASHER, LOCK: GEAR COVER TO FRONT PLATE MTG MS35340-48 (96906)	EA	14	*	*	*	*	*	*	*	*	6	30
PAFZZ	5305-269-3210	SCREW, CAP, HEXAGON HEAD: TAPPET COVER MTG MS90725-59 (96906)	EA	14	*	*	*	*	*	*	*	*	6	31
PAFZZ	5310-080-6004	WASHER, FLAT: TAPPET COVER MTG MS27183-14 (96906)	EA	14	*	*	*	*	*	*	*	*	6	31



Current part is item (23) on diagram. Available at www.oshkosequipment.com

Current part is item (23) on diagram. Available at www.oshkoshequipment.com

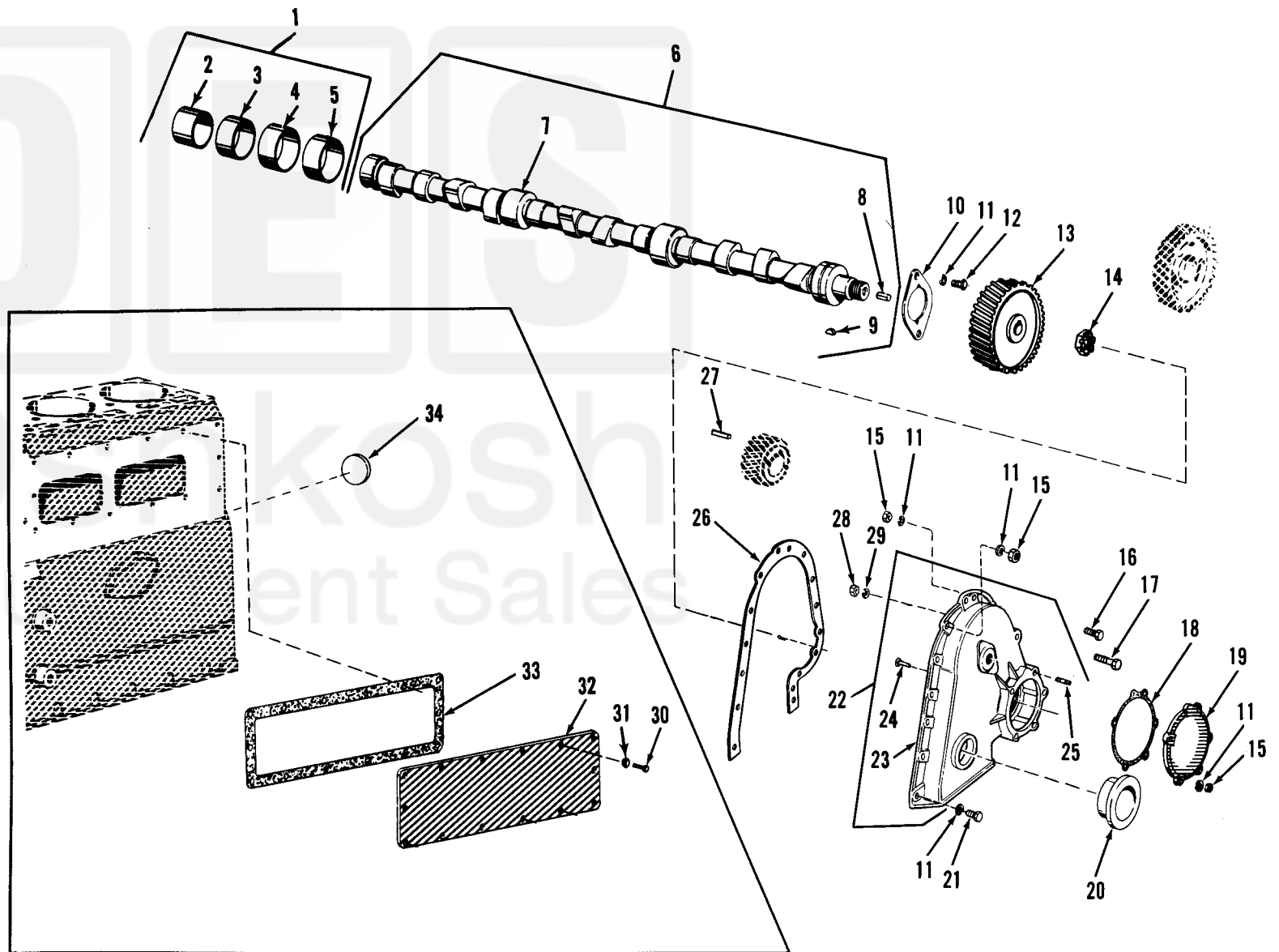

TA010712

Figure 6. Camshaft Gear Cover and Associated Parts.

Current part is item (23) on diagram. Available at www.oshkoshequipment.com